

A SIGNAL ENHANCED PORTABLE RAMAN PROBE FOR ANESTHETIC GAS MONITORING

S. Schlüter^{a,b}, S. Asbach^c, N. Popovska-Leipertz^d, Th. Seeger^{c,b}, A. Leipertz^{a,b}

^a Institute of Engineering Thermodynamics, University of Erlangen-Nuremberg, Erlangen, 91058, Germany

^b Erlangen Graduate School in Advanced Optical Technologies (SAOT), University of Erlangen-Nuremberg, Erlangen, 91052, Germany

^c Institute of Engineering Thermodynamics, University of Siegen, Siegen, 57076, Germany

^d ESYTEC Energie- und Systemtechnik GmbH, Erlangen, 91058, Germany

Corresponding author: Sebastian.schlueter@uni-siegen.de

Article info

Received 23.01.15, accepted 25.02.15

doi: 10.17586/2226-1494-2015-15-2-218-226

Article in English

For citation: Schlüter S., Asbach S., Popovska-Leipertz N., Seeger Th., Leipertz A. A signal enhanced portable raman probe for anesthetic gas monitoring. *Scientific and Technical Journal of Information Technologies, Mechanics and Optics*, 2015, vol.15, no. 2, pp. 218–226. (in English)

Abstract. The spontaneous Raman scattering technique is an excellent tool for a quantitative analysis of multi-species gas mixtures. It is a noninvasive optical method for species identification and gas phase concentration measurement of all Raman active molecules, since the intensity of the species specific Raman signal is linearly dependent on the concentration. Applying a continuous wave (CW) laser it typically takes a few seconds to capture a gas phase Raman spectrum at room temperature. Nevertheless in contrast to these advantages the weak Raman signal intensity is a major drawback. Thus, it is still challenging to detect gas phase Raman spectra in a low-pressure regime with a temporal resolution of only a few 100 ms. In this work a fully functional gas phase Raman system for measurements in the low-pressure regime ($p \geq 980$ hPa (absolute)) is presented. It overcomes the drawback of a weak Raman signal by using a multipass cavity. A description of the sensor setup and of the multipass arrangement will be presented. Moreover the complete functionality of the sensor system will be demonstrated by measurements at an anesthesia simulator under clinical relevant conditions and in comparison to a conventional gas monitor.

Keywords: Raman scattering; multi species gas sensor; low pressure; anesthesia monitor; multipass cavity; short sampling time; simultaneous online concentration information

Acknowledgements. This project is supported by the German Federal Ministry of Education and Research (BMBF), project grants No 13EX1015A, 13EX1015B and 13EX1015L. The authors thank in particular the Erlangen Graduate School in Advanced Optical Technologies (SAOT) and Medical Valley EMN.

УСОВЕРШЕНСТВОВАННЫЙ ПОРТАТИВНЫЙ РАМАНОВСКИЙ АНАЛИЗАТОР ДЛЯ АНЕСТЕЗИРУЮЩИХ ГАЗОВЫХ СМЕСЕЙ

С. Шлютер^{a,b}, С. Асбах^c, Н. Поповска-Лейперц^d, Т. Зеегер^{c,b}, А. Лейперц^{a,b}

^a Институт технологий термодинамики, Университет Эрлангена-Нюрнберга, Эрланген, 91058, Германия

^b Высшая школа передовых оптических технологий (SAOT), Университет Эрлангена-Нюрнберга, Эрланген, 91052, Германия

^c Институт технологий термодинамики, Университет Зигена, Зиген, 57076, Германия

^d ESYTEC Energie- und Systemtechnik GmbH, Эрланген, 91058, Германия

Адрес для переписки: Sebastian.schlueter@uni-siegen.de

Информация о статье

Поступила в редакцию 23.01.15, принята к печати 25.02.15

doi: 10.17586/2226-1494-2015-15-2-218-226

Язык статьи – английский

Ссылка для цитирования: Шлютер С., Асбах С., Поповска-Лейперц Н., Зеегер Т., Лейперц А. Усовершенствованный портативный рамановский анализатор для анестезирующих газовых смесей // Научно-технический вестник информационных технологий, механики и оптики. 2015. Том 15. № 2. С. 218–226.

Аннотация. Спонтанное рамановское рассеяние представляет собою прекрасный метод количественного анализа многокомпонентных газовых смесей. Это неразрушающий оптический метод идентификации состава вещества и измерения концентрации компонентов газа, включающих в себя рамановские активные молекулы. При этом интенсивность специфического рамановского сигнала прямо пропорциональна концентрации. При использовании лазерного излучения в непрерывном режиме при комнатной температуре требуется всего несколько секунд для получения рамановского спектра газовой смеси. В то же самое время серьезным недостатком метода является малая интенсив-

ность рамановского сигнала. По этой причине существует проблема детектирования состава газовой смеси по рамановским спектрам при низких давлениях компонентов газа с временным разрешением порядка сотен миллисекунд.

В данной работе представлена конкретная работающая система газового анализа на основе рамановского рассеяния при низких давлениях компонентов (абсолютное давление $p \geq 980$ гПа). Применение многопроходной полости позволяет компенсировать слабую величину рамановского сигнала. Более того, работоспособность представленной сенсорной системы продемонстрирована измерениями в ходе процедуры анестезии в конкретных клинических условиях и при сопоставлении результатов измерений с обычно применяемыми средствами газового анализа.

Ключевые слова: рамановское рассеяние, многокомпонентный анализатор газов, низкое давление, контроль процесса анестезии, многопроходная полость, малое время анализа, информация о концентрации газа в реальном режиме времени.

Благодарности. Проект осуществлен при поддержке Федерального министерства по образованию и науке ФРГ, номера грантов гранты № 13EX1015A, 13EX1015B и 13EX1015L. Особую благодарность авторы выражают Erlangen Graduate School in Advanced Optical Technologies (SAOT) и Medical Valley EMN.

Introduction

An online species concentration determination of gas mixtures is of great interest in a wide range of technical and medical applications. For process reasons the gas sample has often a relatively low pressure of some 100 hPa. Typical examples for such gas mixtures are biogas or natural gas [1–4]. Their gas composition and gas properties like the caloric value and the density is strongly depending on the production process or the exploration site. This has to be taken into account when the gas is injected into the existing gas supply net or used in a combustion process. In either case, the final product gas composition has to be monitored. Another example is the breathing gas composition of a patient during an anesthesia procedure. A continuous monitoring of this gas composition is of vital importance to ensure the patient's safety. Therefore the concentration of the various anesthetic gases, which are added to the breathing gas and the oxygen, carbon dioxide and water vapor concentration is necessary to be monitored [5]. Since inspired and expired breathing cycles take place within a few seconds the gas composition is changing rapidly. This requires a fast and precise measurement of all gas species within a time resolution of 200 ms to 500 ms during each breath event. Up to now a lot of gas monitoring solutions for all species of interest are based on a sidestream analysis where a sample of inspiratory or expiratory gas is withdrawn continuously. Commercial available anesthesia monitoring systems are usually a combination of electrochemical or paramagnetic sensors and IR-absorption spectrometers [6]. These systems have several drawbacks. Since various independent sensors are used, the total gas concentration may differ from 100 vol.% e.g. if one sensor is miscalibrated, this can lead to conflicting information increasing the potential for a wrong decision of the caregiver [7, 8]. A further disadvantage of conventional systems is the need for treatment of the gas sample like e.g. filtering and drying before entering the sensors system. It is also not possible to detect all occurring species. For instance, the nitrogen and the water vapor concentration are not measured by such commercial available systems.

Spontaneous Raman scattering provides an interesting alternative measurement method to identify and determine all relevant species within the breathing gas during anesthesia procedures [9, 10]. In principle, it gives the possibility for the simultaneous detection of virtually all polyatomic species with high temporal resolution with one sensor system. Due to the high content of information, spontaneous Raman scattering is among the most established spectroscopic techniques. Concerning gas phase diagnostics in the field of combustion it is mainly used to determine the local gas sample composition, e.g. in the mixture formation processes [11–15] and in flames [16–19]. In spite of being a challenging technique due to a weak signal, the linear Raman spectroscopy seems to be perfectly suited for the application in gas sensor monitoring and in anesthesia procedures [9]. Additionally there is no need for a sample preparation, which enables an access to in situ measurements inside the breathing circuit. Previous efforts to use a Raman based sensor system for the online monitoring had some restrictions concerning the accuracy caused by channel cross-sensitivity especially for the parallel use of anesthetic agents [20–23]. Therefore, only three of five anesthetic agents could be detected by such systems. Furthermore, an additional gas treatment was necessary for the application of these sensors systems. The measurement cell was located inside the laser resonator and had to be protected from condensing water vapor. In contrast to that, the sensor presented in this paper requires no sample preparation and can detect all five anesthetic agents, CO₂, N₂ and H₂O, at a pressure of 980 hPa within a short measurement time. The development of the sensor hardware and especially the signal enhancement by using a multipass approach is described in detail. Finally, its application is demonstrated successfully during a simulated anesthesia process and compared with conventional gas monitoring system at the anesthesia test center of the University Hospital in Erlangen.

Measurement principle

The measurement principle of the developed monitoring system is based on the linear Raman scattering, which is well described in literature (see [24–26]). Therefore, only a brief description will be given here. If monochromatic light enters a gas volume, the largest part of the light passes through the gas volume without any interaction. Only a small amount interacts with the gas molecules and part of this is scattered. The scattered light consists mainly of two different parts. The major part is scattered with the same frequency as the exciting laser

beam and is known as Rayleigh scattering. With an intensity of approximately three orders less, scattered light, which is shifted in frequency with respect to the incident radiation, can be observed. This process is called spontaneous Raman scattering and the frequency-shift is characteristic for a certain species. The shorter wavelength shifted bands are called anti-Stokes transitions, the longer wavelength shifted bands are called Stokes transitions. If the molecules are treated as a non-rigid rotator, the energy levels of diatomic molecules interacting with the incoming laser light can be specified as a function $E(\nu, J)$. Beside the rotational (J) and vibrational (ν) quantum number $E(\nu, J)$ depends only on molecule specific constants, which lead to an individual Raman spectrum for each molecule, that can be used as a fingerprint for a species identification purposes [27, 28].

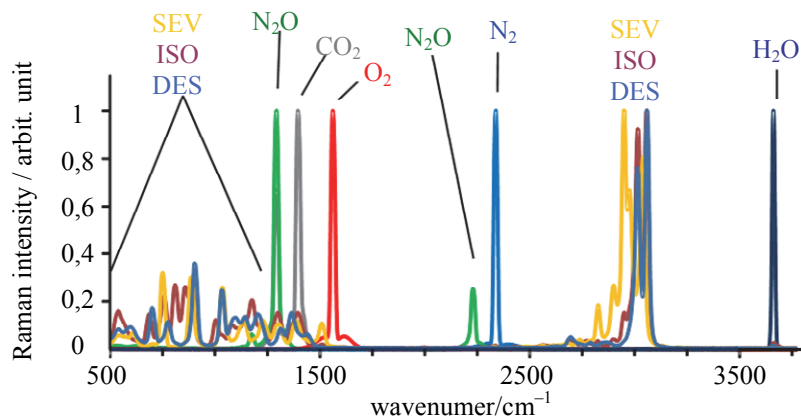

Fig. 1. Gas phase Q-branch vibrational spectra of species typical for an anesthesia process

Anesthesia processes relevant to vibrational Raman spectra are shown in Fig. 1. The spectra of the pure substances N_2 , O_2 , CO_2 , H_2O , N_2O , sevoflurane (SEV), isoflurane (ISO) and desflurane (DES) are normalized to one. For quantitative species concentration determination, it is advantageous that the intensity of each Raman line is linearly depending on the number density of the molecules inside the measurement volume:

$$I_i = kI_0n_i l \left(\frac{\partial \sigma}{\partial \Omega} \right) \Omega, \quad (1)$$

where k is a setup specific constant, I_0 – the intensity of the exciting laser radiation, n_i is the number density of species i , l is the length of the probe volume, $\partial \sigma / \partial \Omega$ – the differential Raman scattering cross-section and Ω is the observation angle.

Experimental setup

The Raman probe consists of a laser source, a temperature stabilized measurement cell with four optical accesses and a spectrometer. During online measurements the gas sample inside the measurement cell is constantly renewed. Since the excitation wavelength is in principle arbitrary, a compact, frequency-doubled Nd:YVO₄ cw laser is used. Due to the relatively low Raman signal intensity, it is challenging to realize short measurement times for low-pressure gas samples. In order to increase the Raman signal significantly a robust multipass approach was used. The laser is focused inside the test cell, which is centered within the multipass cavity. The scattered signal is observed at an angle of 90° with respect to the incoming and redirected laser beams. This 90°-setup offers the possibility of a sufficient stray light reduction. By redirecting the Raman signal into the spectrometer, which is scattered under an angle of 270° an additional signal gain is achieved. The Raman signal is coupled into a two meter optical fiber with a high transmissivity in a wavelength range of 400 nm to 1 μm which is connected to the entrance slit of the spectrograph. There the signal is spectrally resolved and detected by a sensitive CCD camera. The resulting spectral observation range is 300 cm⁻¹ to 4600 cm⁻¹ covering all relevant molecules of interest for nearly all gas phase applications. The measurements were performed at gas samples without any additional treatment, which simplifies the measurement procedure significantly.

Signal amplification. To increase the Raman signal a suitable multipass cavity was built up and integrated in the sensor system. In the literature several different possible types of cavities and light traps are described [29–33]. The basic amplification principle in all these types of cavities is always the same.

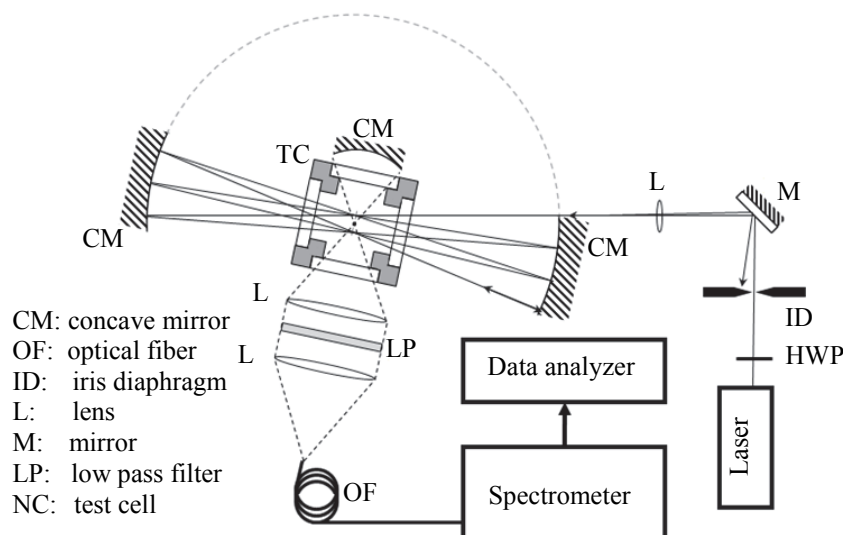

Fig.2. Near-confocal cavity (NCC) with two confocal mirrors

The stimulating laser beam passes through the measurement volume as often as possible. Starting from a robust 90°-setup, a near-confocal cavity (NCC) arrangement was used in this study as shown in Fig. 2. The signal gain of such a multipass arrangement is dominated by the optical losses per pass. A theoretical treatment about the multipass gain analysis can be found in [34]. The reflectivity and transmissivity of the individual surfaces in the beam pass have a huge impact on the single-pass efficiency η , which is defined as

$$\eta = \left(\prod_{i=0}^{m-1} R_i \right) \left(\prod_{j=0}^{k-1} T_j \right) \tag{2}$$

where the number of reflective surfaces is given by i and the number of translucent components by j , R_i describes the reflectivity of the surface i and T_j the transmissivity of surface j . The signal gain G_A is given by equation:

$$G_A = \frac{1 - \eta^p}{1 - \eta}, \tag{3}$$

where p is the number of passes. The limit for $p \rightarrow \infty$ shows the maximum achievable gain (G_{Max}) for a given cavity efficiency η .

$$\lim_{p \rightarrow \infty} G_A = \frac{1}{1 - \eta} \tag{4}$$

In Fig. 3 the measured signal gain of the NCC is plotted over the number of beam passes. The signal gain for O_2 , N_2 and H_2O was determined since the Raman signals of these molecules are well distributed over the spectral region of interest. In the experiment, 52 beam passes could be realized in the NCC, resulting in a signal gain factor of 17.15. The limiting factors were the size of the concave mirrors and the beam acceptance angle of the sample cell. From these measurements the respective η can be determined as it is shown in Fig. 3.

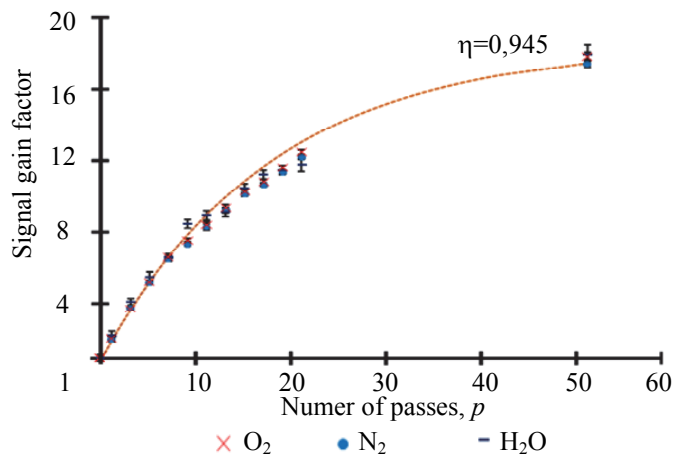

Fig.3. Signal gain and the cavity quality η for a near-confocal cavity

Subsequently, the maximal possible gain amplification can be calculated from equation (3). This results in a theoretical maximum signal gain of $G_{\text{Max}} = 18.52$ for the configuration described above. The NCC needs only a few optical components compared with other cavity types [30, 32, 35]. Therefore, a relatively large η can be achieved. Additionally, depending on the size of the mirrors, a large number of passes can be realized in the NCC configuration leading to a larger signal amplification. To avoid that, the lasers beam is back-reflected exactly to its origin when the maximum number of passes is realized, the cavity adjustment was slightly misaligned. This ensured that the outgoing beam was deflected to prevent it from entering the laser source again (see Fig. 2).

Data evaluation procedure

The data evaluation procedure, which is used in this work, is based on a contour-fit procedure and determines the relative species concentration in volume percent fully automatically. The intensity of the Raman bands is linear depending on the number density of the molecules n (see Eq. (1)). Nevertheless, also the detection system e.g. the spectrometer including the CCD-detector should have a linear behavior within the operation range, otherwise the data evaluation procedure has to compensate this nonlinear behavior. This was tested and as an example in Fig. 4 the measured Raman signal of DES in dependence of pressure is shown. Since in a low pressure regime the ideal gas law is valid in good approximation, the pressure p is proportional to the density of the moles number n/V . A correlation coefficient is indicated in Fig. 4 by $r_{xy}^2 = 0.99978$. It is equal to 1 for a perfect positive correlation and to zero, if there is no linear dependency.

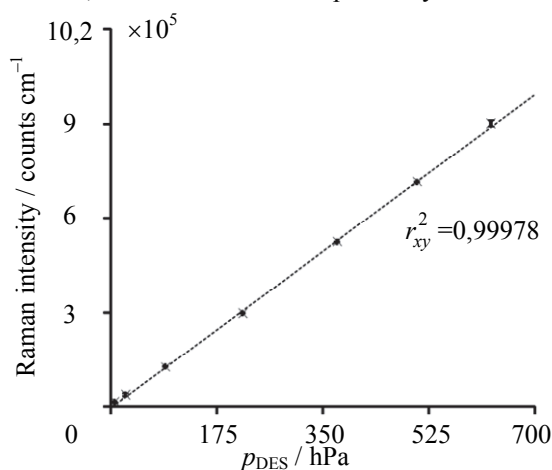

Fig. 4. Measured signal intensity of DES over partial pressure

Data evaluation. A typical anesthetic gas sample may contain up to six substances O_2 , N_2O , CO_2 , N_2 , H_2O and for instance DES as anesthetic agent (in some cases even more substances are used). The measured signal intensity in dependence of the Raman shift is expressed by a finite vector \vec{S}_M . The contour-fit procedure, based on the Levenberg-Marquardt algorithm, compares the measured signal \vec{S}_M with a synthetic spectrum \vec{S}_{Fit} consisting out of the spectra of the pure substances \vec{s}_e . This procedure can be formulated as an optimization problem:

$$\min \left(\frac{1}{q} \sum_{x=0}^{q-1} (S_{\text{Fit}}(x) - S_M(x))^2 \right), \quad (5)$$

where $S_{\text{Fit}}(x)$ is one data point of the spectrum of q values respecting the spectral position, and $S_M(x)$ is one data point of the measured spectrum with the same number of elements. The goal of that optimization problem is to find the synthesized spectrum \vec{S}_{Fit} that has the smallest deviation from the measured spectrum \vec{S}_M . The synthetic spectrum \vec{S}_{Fit} is a linear superposition of the Raman spectra of the pure substances and is described by

$$\vec{S}_{\text{Fit}} = \sum_{e=0}^{z-1} a_e \vec{s}_e \quad (6)$$

The contour-fit procedure solves the optimization problem in Eq. (5) by varying the coefficients a_e in Eq. (6) for each stored spectrum \vec{s}_e of the pure species e . In the calculated spectra z represents the total number of species. If the setup specific scattering cross-sections of the individual substances are determined by a calibration, it is possible to calculate the concentrations c_e of the species e by

$$c_e = b_e \cdot a_e, \tag{7}$$

where b_e is the calibration coefficient of species e .

Experimental Results

For a test under clinical conditions the Raman sensor was operated in line with a commercial anesthetic gas monitor (AGM, Dräger Perseus®). The measurements were performed in an anesthesia test center at the University Hospital in Erlangen. The principle setup is illustrated in Fig. 5. The anesthesia system consists of a gas mixer, a circular system with CO₂ absorber and a ventilator; it delivers breathing and anesthetic gases. Calibration measurements were performed for N₂, O₂, N₂O and CO₂ by using a commercial available calibration gas. For the anesthetic agents and H₂O self-made binary gas mixtures consisting of N₂ and the desired species were used. The system was connected to a human patient simulator® (HPS), which has a realistic breathing behavior and delivers depending on the surgery status a clinical relevant respiratory gas composition for the expiratory gases. The online Raman measurements were performed with a continuous gas flow through the test cell. The operation of the Raman probe needed no sample preparation and was connected directly to the y-piece of the semi-closed anesthetic circle system.

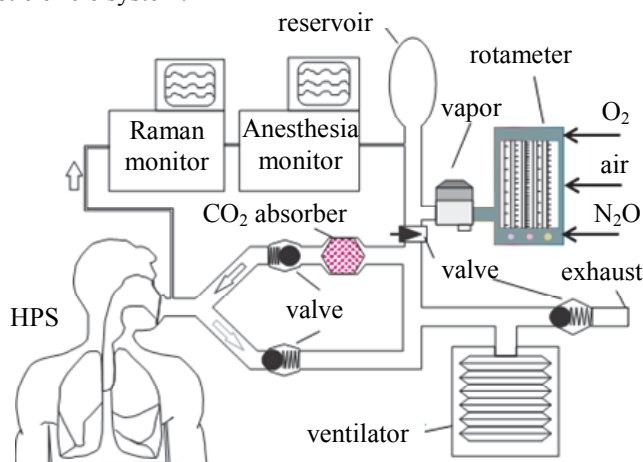

Fig. 5. Test setup for evaluating the Raman monitor

Nevertheless, for the conventional monitoring system the sample gas had to be dried and was therefore guided through a water trap. Based on this experimental setup Raman spectra of respiratory gas mixtures consisting of O₂, N₂, CO₂, H₂O and SEV were recorded with the Raman probe under clinical relevant conditions. The measurement and evaluation time for the Raman probe was set to 250 ms / spectrum for all measurements. The spectra were evaluated online and compared to measurement results achieved by the AGM.

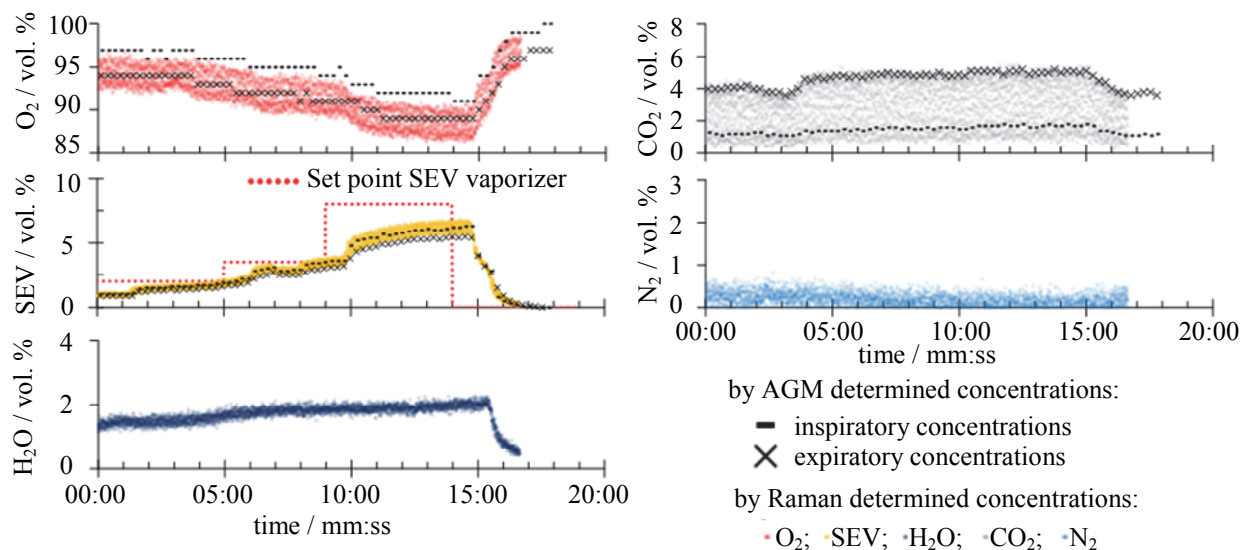

Fig. 6. Comparison of the Raman probe and an AGM

As an example, a measurement series taken over 16 minutes is shown in Fig. 6. Due to software limitations by the AGM, only each 16 sec one complete dataset containing the inspiratory and expiratory concentration was displayed and stored. At the beginning of the illustrated time period the SEV concentration

was 1 vol.% and the anesthetists increased the SEV set point value at the vaporizer stepwise from 2 vol.% to 3.5 vol.% and then to 8 vol.%. After the actual value reached 6.5 vol.% the SEV vaporizer was reduced to 0 vol.%. During the whole time span the O₂ concentration inside the breathing circuit was kept between 85 vol.% and 100 vol.%, therefore the measured N₂ concentration is less than 1 vol.%. Additionally a slightly increasing H₂O concentration can be observed caused by water, which is accumulated in the CO₂-absorber (see Fig. 5). At the end of the illustrated anesthesia phase the circular system is flushed by pure O₂, which leads to a significant increase of the O₂ concentration and to a reduction of all other species. Especially H₂O and SEV are flushed out of the breathing circuit. During the complete anesthesia procedure a very good agreement between the two monitoring systems was achieved. The Raman probe delivered in addition the N₂ and the H₂O concentration. In Fig. 7 the concentrations of CO₂, O₂ and SEV are shown in more detail. The species concentrations measured with the Raman probe show clearly well resolved single breathing events. The CO₂ concentration oscillates between 0 vol.% and 4 vol.%, this are typical physiological values. During the presented time interval the SEV concentration was kept constant at 2 vol.%.

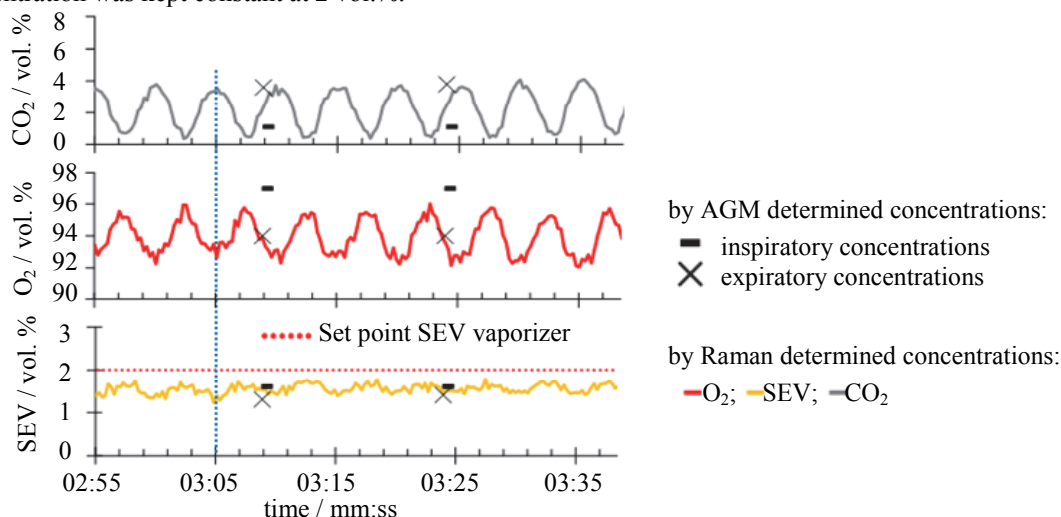

Fig.7. Detailed view on selected species with single resolved breathing events

For verification purpose, a gas mixture consisting of CO₂, N₂, N₂O and O₂ was analyzed by a gas chromatograph (GC) and by the Raman sensor. The result of this comparison is listed in Table. Even for a low concentration (see e.g. CO₂) the relative deviation (f) between both measurements is quite small. The standard deviation σ has been determined by 100 single shot Raman measurements.

Species	GC, vol.%	Raman, vol.%	f , %	σ , vol.%
CO ₂	1,89	1,86	-1,59	0,019
N ₂	7,57	7,56	-0,13	0,035
N ₂ O	45,21	45,12	-0,20	0,128
O ₂	45,33	45,47	0,31	0,045

Table. Comparison of Raman and gas chromatography (GC) measurements

Summary

The presented Raman probe is capable to identify and quantify all species of interest during an anesthesia procedure, which is typically at an absolute pressure of about 980 hPa performed. In contrast to established monitoring devices, the probe enables the simultaneous detection of virtually all volatile narcotic agents and respiratory relevant gases, e.g. O₂, CO₂, N₂O, sevoflurane, isoflurane, desflurane and additionally N₂ and H₂O. The Raman probe is able to measure the gas species concentration online without any sample preparation and is thus in principal applicable as a mainstream monitor. Since all species are measured simultaneously by the Raman sensor the concentration information for all species is received at the same time. This is not the case for conventional monitoring systems consisting of several independent sensors. To increase the Raman signal and to enable short measurement times of 250 ms the sensor is equipped with the near-confocal cavity. In a test under clinical relevant conditions and in comparison with conventional gas monitoring system, the applicability of this Raman system for anesthetic gas monitoring was demonstrated. All species of interest were measured online with the data acquisition time of 250 ms. This gave the possibility to resolve a single breathing event. During the complete anesthesia procedure a very good agreement between the Raman system and the conventional anesthesia monitor was achieved. An additional comparison with gas chromatograph measurements demonstrates the high quality of the Raman sensor measurements.

References

1. Egermann J., Jonuscheit J., Seeger T., Leipertz A. Investigation of diode laser-based multi-species gas sensor concepts // *Technisches Messen*. 2001. V. 68. N 9. P. 401–405.
2. Eichmann S.C., Kiefer J., Benz J., Kempf T., Leipertz A., Seeger T. Determination of gas composition in a biogas plant using a Raman-based sensor system // *Measurement Science and Technology*. 2014. V. 25. N 7. Art. 075503. doi: 10.1088/0957-0233/25/7/075503
3. Kiefer J., Seeger T., Steuer S., Schorsch S., Weigl M.C., Leipertz A. Design and characterization of a Raman-scattering-based sensor system for temporally resolved gas analysis and its application in a gas turbine power plant // *Measurement Science and Technology*. 2008. V. 19. N 8. Art. 085408. doi: 10.1088/0957-0233/19/8/085408
4. Schlüter S., Seeger T., Popovska-Leipertz N., Leipertz A. Laser basierte on-line-analyse von biogasen mit einer Raman-sonde // *Technisches Messen*. 2014. V. 81. N 11. P. 546–553. doi: 10.1515/teme-2014-1050
5. Wilhelm W., Khuenl-Brady K., Beaufort A.M., Tassonyi E., Meistelman C. Neuromuscular monitoring: instructions of various national professional societies and their practical realization // *Anaesthesist*. 2000. V. 49. N 1. P. S7–S8.
6. *Basics of Anesthesia* / Eds R.D. Miller, M.C. Pardo. 6th ed. Elsevier, 2011. 832 p.
7. Needham M.J., Denton M. Failure of medical air gas outlet // *Anaesthesia*. 2014. V. 69. N 5. P. 523–524. doi: 10.1111/anae.12693
8. Cassidy C.J., Smith A., Arnot-Smith J. Critical incident reports concerning anaesthetic equipment: analysis of the UK National Reporting and Learning System (NRLS) data from 2006–2008 // *Anaesthesia*. 2011. V. 66. N 10. P. 879–888. doi: 10.1111/j.1365-2044.2011.06826.x
9. Schlüter S., Popovska-Leipertz N., Leipertz A., Seeger T. Concept for an anesthetic gas sensor based on Raman scattering // *Proc. 7th Russian-Bavarian Conference on Biomedical Engineering*. Erlangen, 2011.
10. Schlueter S., Krischke F., Popovska-Leipertz N., Seeger T., Breuer G., Jeleazcov C., Schuettler J., Leipertz A. Quantitative measurement of the volatile anesthetic agents and respiratory gases during anesthesia by a compact, robust and mobile sensor based on linear Raman scattering // *Proc. Laser Applications to Chemical, Security and Environmental Analysis (LACSEA 2014)*. Seattle, USA, 2014.
11. Deublein D., Steinhäuser A. *Biogas from Waste and Renewable Resources*. 2nd ed. Wiley-VCH, 2010. 578 p.
12. Taschek M., Egermann J., Schwarz S., Leipertz A. Quantitative analysis of the near-wall mixture formation process in a passenger car direct-injection diesel engine by using linear Raman spectroscopy // *Applied Optics*. 2005. V. 44. N 31. P. 6606–6615. doi: 10.1364/AO.44.006606
13. Egermann J., Koebecke W., Ipp W., Leipertz A. Investigation of the mixture formation inside a gasoline direct injection engine by means of linear Raman spectroscopy // *Proc. 28th Int. Symposium on Combustion*. Edinburgh, UK, 2000. V. 28. N 1. P. 1145–1151.
14. Zhao H., Zhang S. Quantitative measurements of in-cylinder gas composition in a controlled auto-ignition combustion engine // *Measurement Science and Technology*. 2008. V. 19. N 1. Art. 015409. doi: 10.1088/0957-0233/19/1/015409
15. Kiefer J., Kozlov D.N., Seeger T., Leipertz A. Local fuel concentration measurements for mixture formation diagnostics using diffraction by laser-induced gratings in comparison to spontaneous Raman scattering // *Journal of Raman Spectroscopy*. 2008. V. 39. N 6. P. 711–721. doi: 10.1002/jrs.1965
16. Egermann J., Seeger T., Leipertz A. Application of 266-nm and 355-nm Nd:YAG laser radiation for the investigation of fuel-rich sooting hydrocarbon flames by Raman scattering // *Applied Optics*. 2004. V. 43. N 29. P. 5564–5574. doi: 10.1364/AO.43.005564
17. Meier W., Keck O. Laser Raman scattering in fuel-rich flames: background levels at different excitation wavelengths // *Measurement Science and Technology*. 2002. V. 13. N 5. P. 741–749. doi: 10.1088/0957-0233/13/5/312
18. Meier W., Barlow R.S., Chen Y.-L., Chen J.-Y. Raman/Rayleigh/LIF measurements in a turbulent CH₄/H₂/N₂ jet diffusion flame: experimental techniques and turbulence-chemistry interaction // *Combustion and Flame*. 2000. V. 123. N 3. P. 326–343. doi: 10.1016/S0010-2180(00)00171-1
19. Kojima J., Nguyen Q.-V. Single-shot rotational Raman thermometry for turbulent flames using a low-resolution bandwidth technique // *Measurement Science and Technology*. 2008. V. 19. N 1. Art. 015406. doi: 10.1088/0957-0233/19/1/015406
20. Gregonis D., van Wagenen R., Coleman D., Mitchell J. Commercial anesthetic. Respiratory gas monitor utilizing Raman spectroscopy // *Proceedings of SPIE – The International Society of Optical Engineering*. 1990. V. 1336. P. 247–255.
21. Wagenen R.A., Westenskow D.R., Benner R.E., Gregonis D.E., Coleman D.L. Dedicated monitoring of anesthetic and respiratory gases by Raman scattering // *Journal of Clinical Monitoring*. 1986. V. 2. N 4. P. 215–222. doi: 10.1007/BF02851168
22. Lockwood G.G., Landon M.J., Chakrabarti M.K., Whitwam J.G. The Ohmeda Rascal II. A new gas analyser for anaesthetic use // *Anaesthesia*. 1994. V. 49. N 1. P. 44–53.

23. Westenskow D.R., Coleman D.L. Can the Raman scattering analyzer compete with mass spectrometers: an affirmative reply // *Journal of Clinical Monitoring*. 1989. V. 5. N 1. P. 34–36. doi: 10.1007/BF01618368
24. Schrader B., Bougeard D. *Infrared and Raman Spectroscopy: Methods and Applications*. NY: Wiley-VCH, 1995. 808 p.
25. Tobin M.C. *Laser Raman Spectroscopy*. In: Elving P.J., Kolthoff I.M. *Chemical Analysis, a Series of Monographs on Analytical Chemistry and Its Application*. V. 35. NY: Wiley-Interscience, 1971. P. 1–30.
26. Leipertz A. Nutzung von laser-Raman-verfahren in der verbrennungstechnik // *Chemie-Ingenieur-Technik*. 1989. V. 61. N 1. P. 39–48.
27. Seeger T. Moderne Aspekte der linearen und nichtlinearen Raman-streuung zur bestimmung thermodynamischer zustandsgrößen in der gasphase // *ESYTEC Energie- und Systemtechnik*. 2006. V. 6.3.
28. Herzberg G. *Molecular Spectra and Molecular Structure*. V. 1. *Spectra of Diatomic Molecules*. Krieger, Malabar, 1963. 672 p.
29. Kiefer W., Bernstein H.J., Wieser H., Danyluk M. The vapor-phase Raman spectra and the ring-puckering vibration of some deuterated analogs of trimethylene oxide // *Journal of Molecular Spectroscopy*. 1972. V. 43. N 3. P. 393–400. doi: 10.1016/0022-2852(72)90050-1
30. Hill R.A., Mulac A.J., Hackett C.E. Retroreflecting multipass cell for Raman scattering // *Applied Optics*. 1977. V. 16. N 7. P. 2004–2006. doi: 10.1364/AO.16.002004
31. Hill R.A., Hartley D.L. Focused, multiple-pass cell for Raman scattering // *Applied Optics*. 1974. V. 13. N 1. P. 186–192. doi: 10.1364/AO.13.000186
32. Daams H.-J., Hassel E.P. Multipass cavity: collinear and self-focusing // *Applied Optics*. 1983. V. 22. N 14. P. 2066–2067. doi: 10.1364/AO.22.002066
33. Santavicca D.A. A high energy, long pulse Nd: Yag laser multipass cell for Raman scattering diagnostics // *Optics Communications*. 1979. V. 30. N 3. P. 423–425. doi: 10.1016/0030-4018(79)90385-7
34. Waldherr G.A., Lin H. Gain analysis of an optical multipass cell for spectroscopic measurements in luminous environments // *Applied Optics*. 2008. V. 47. N 7. P. 901–907. doi: 10.1364/AO.47.000901
35. Losev L.L., Yoshimura Y., Otsuka H., Hirakawa Y., Imasaka T. A multipass hydrogen Raman shifter for the generation of broadband multifrequencies // *Review of Scientific Instruments*. 2002. V. 73. N 5. P. 2200. doi: 10.1063/1.1468686

- Sebastian Schlüter** – scientific assistant, Institute of Engineering Thermodynamics, University of Erlangen-Nuremberg, Erlangen, 91058, Germany; scientific assistant, Erlangen Graduate School in Advanced Optical Technologies (SAOT), University of Erlangen-Nuremberg, 91052, Erlangen, Germany, Sebastian.schlueter@uni-siegen.de
- Sascha Asbach** – student, Institute of Engineering Thermodynamics, University of Siegen, Siegen, 57076, Germany, Sascha.asbach@student.uni-siegen.de
- Nadejda Popovska-Leipertz** – D.Sc., Professor (Emeritus), Managing Director, ESYTEC Energie- und Systemtechnik GmbH, Erlangen, 91058, Germany, popovska@esytec.de
- Thomas Seeger** – D.Sc., Professor, Mentor, Institute of Engineering Thermodynamics, University of Siegen, Siegen, 57076, Germany; Professor, Mentor, Erlangen Graduate School in Advanced Optical Technologies (SAOT), University of Erlangen-Nuremberg, Erlangen, 91052, Germany, Thomas.Seeger@uni-siegen.de
- Alfred Leipertz** – D.Sc, Professor (Emeritus), Institute of Engineering Thermodynamics, University of Erlangen-Nuremberg, Erlangen, 91058, Germany; Professor (Emeritus), Erlangen Graduate School in Advanced Optical Technologies (SAOT), University of Erlangen-Nuremberg, Erlangen, 91052, Germany, sek@litt.uni-erlangen.de
- Шлютер Себастиан** – научный сотрудник, Институт технологий термодинамики, Университет Эрлангена-Нюрнберга, Эрланген, 91058, Германия; научный сотрудник, Высшая школа передовых оптических технологий (SAOT), Университет Эрлангена-Нюрнберга, Эрланген, 91052, Германия, Sebastian.schlueter@uni-siegen.de
- Асбах Сааша** – студент, Институт технологий термодинамики, Университет Зигена, Зиген, 57076, Германия, Sascha.asbach@student.uni-siegen.de
- Поповска-Лейперц Надежда** – доктор технических наук, почетный профессор, генеральный директор, ESYTEC Energie- und Systemtechnik GmbH, Эрланген, 91058, Германия, popovska@esytec.de
- Зеегер Томас** – доктор технических наук, профессор, руководитель института, Институт технологий термодинамики, Университет Зигена, Зиген, 57076, Германия; профессор, руководитель, Высшая школа передовых оптических технологий (SAOT), Университет Эрлангена-Нюрнберга, Эрланген, 91052, Германия, Thomas.Seeger@uni-siegen.de
- Лейперц Альфред** – доктор технических наук, почетный профессор, Институт технологий термодинамики, Университет Эрлангена-Нюрнберга, Эрланген, 91058, Германия; почетный профессор, Высшая школа передовых оптических технологий (SAOT), Университет Эрлангена-Нюрнберга, Эрланген, 91052, Германия, sek@litt.uni-erlangen.de